

# FICHE D'HOMOLOGATION HOMOLOGATION FORM



## COMMISSION INTERNATIONALE DE KARTING - FIA



### CADRE DU CHÂSSIS / CHASSIS FRAME



Constructeur	<i>Manufacturer</i>	C.R.G.
Marque	<i>Make</i>	MARANELLO
Modèle	<i>Model</i>	RS 7
Catégorie	<i>Category</i>	ICAJ – ICA – ICC – SICC – ICE
Durée de l'homologation	<i>Validity of the homologation</i>	6 ans / years
Nombre de pages	<i>Number of pages</i>	4

La présente Fiche d'Homologation reproduit descriptions, illustrations et dimensions du cadre du châssis au moment de l'homologation CIK-FIA. Le Constructeur a la possibilité de les modifier, mais seulement dans les limites fixées par le Règlement CIK-FIA en vigueur.

*This Homologation Form reproduces descriptions, illustrations and dimensions of the chassis frame at the moment of the CIK-FIA homologation. The Manufacturer may modify them, but only within the limits set by the CIK-FIA Regulations in force.*

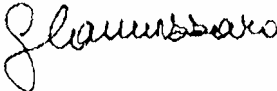

PHOTO VUE DE DESSUS DU CHÂSSIS COMPLET IDENTIQUE À L'UN DES MODÈLES PRÉSENTÉS À L'HOMOLOGATION SANS PARE-CHOC, CARROSSERIE NI PNEUMATIQUES  
PHOTO FROM ABOVE OF COMPLETE CHASSIS IDENTICAL TO ONE OF THE MODELS SUBMITTED FOR HOMOLOGATION WITHOUT BUMPERS, BODYWORK OR TYRES

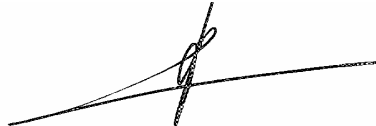
Signature et tampon de l'ASN <i>Signature and stamp of the ASN</i>	Signature et tampon de la CIK-FIA <i>Signature and stamp of the CIK-FIA</i>
 	 

A DESSIN TECHNIQUE DU CADRE

A

TECHNICAL DRAWING OF FRAME

Le dessin technique sert pour identifier la structure et la géométrie principale du cadre.  
 The technical drawing is used for the identification of the structure and the main geometry of the frame.

VUE DE DESSUS / VIEW FROM ABOVE

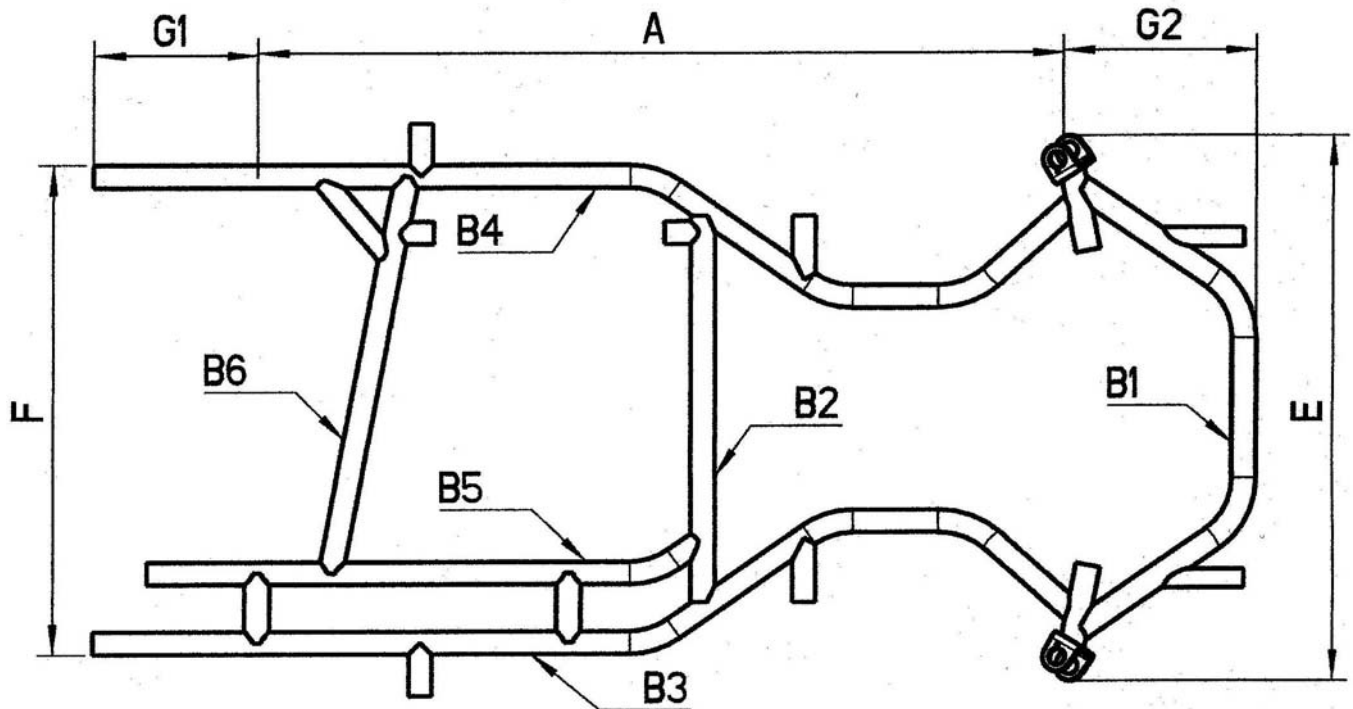

VUE DE CÔTÉ / SIDE VIEW

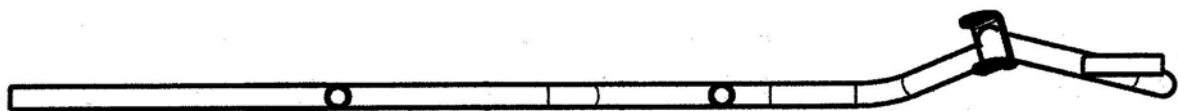

B	COTES	B	DIMENSIONS	
1. Cadre	1. Frame		Données	Tolérances
			Data	Tolerances
A= Empattement mesures fixes	A= Wheel base fixed measurements		1050	<b>+/- 10mm</b>
B= Tubes principaux de la structure, diamètre minimum 21mm, d'une longueur supérieure à 150mm, à l'exception des tubes d'un diamètre inférieur à 21mm et tous les supports pour les accessoires.	B= Main tubes of the structure, minimum diameter of 21mm, length over 150mm, except tubes with a diameter of less than 21mm and all the supports for the accessories.		1) 32 2) 32 3) 30 4) 30 5) 30 6) 32	+/- 0.5mm +/- 0.5mm +/- 0.5mm +/- 0.5mm +/- 0.5mm +/- 0.5mm +/- 0.5mm +/- 0.5mm
C = Nombre de courbes dans les tubes de Ø supérieur à 21mm	C = Number of bends on the tubes with a diameter greater than 21mm.		9	
D = Nombre de tubes ayant un Ø supérieur à 21mm	D = Number of tubes with a diameter greater than 21mm		6	
E = Largeur avant extérieure	E = Outer front width		728	+/- 10mm
F = Largeur arrière extérieure	F = Outer rear width		645	+/- 10mm
<b>G1 = Porte-à-faux arrière des tubes principaux (obligatoire)</b>	<b>G1 = Rear overhang for the main tubes (mandatory)</b>		<b>210</b>	<b>+/- 15mm</b>
<b>G2 = Porte-à-faux avant du tube principal</b>	<b>G2 = Front overhang for the main tube</b>		<b>260</b>	<b>+/- 10mm</b>
H = Les attaches supportant les fusées doivent être soudées ou brasées au cadre	H= The fixations sustaining the stub axles must be welded or brazed to the frame			
I = Les attaches supportant les barres de rigidification doivent être soudées ou brasées au cadre	I= The fixations sustaining the stiffening bars must be welded or brazed to the frame			
<b>Remarque / Remark:</b> Dans les points B, C et D, seuls les tubes principaux d'une longueur supérieure à 150 mm sont à prendre en considération à l'exclusion tous les supports pour accessoires. <i>In points B, C and D, only the main tubes of a length of more than 150 mm are to be taken into consideration, excluding all supports for accessories.</i>				

C	PHOTO DU MARQUAGE DU NUMERO D'HOMOLOGATION	C	PHOTO OF THE HOMOLOGATION NUMBER MARKING
			
	<p><b>Le marquage doit rester clairement visible en permanence</b>  <b>The marking must be clearly visible at all times</b></p>		

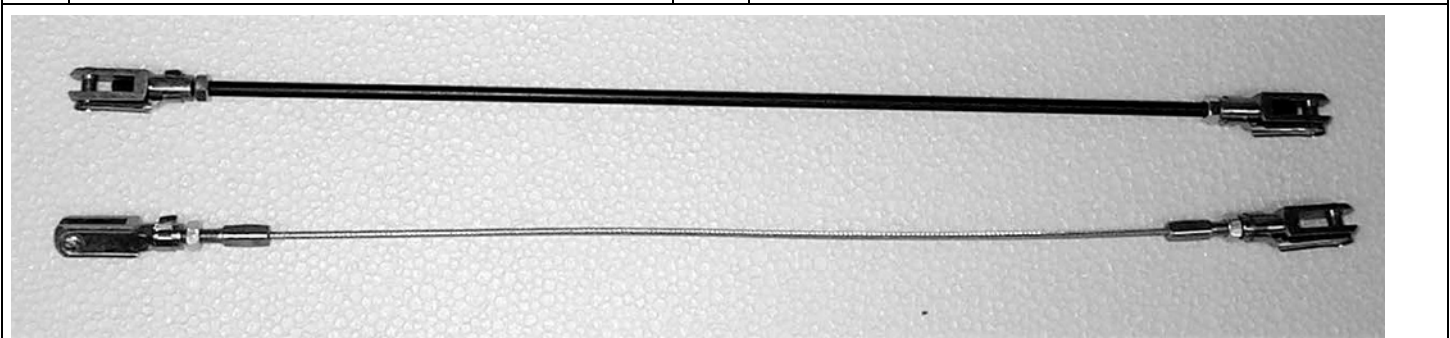
<b>d</b>	PHOTO DE LA COMMANDE DE FREINAGE	<b>d</b>	PHOTO OF BRAKE CONTROL CABLE
			
<p data-bbox="245 685 1340 748"><b>La commande de freinage doit être isolée du châssis et montrer la double commande</b> <b><i>The brake control must be separated from chassis and show the double linkage</i></b></p>			